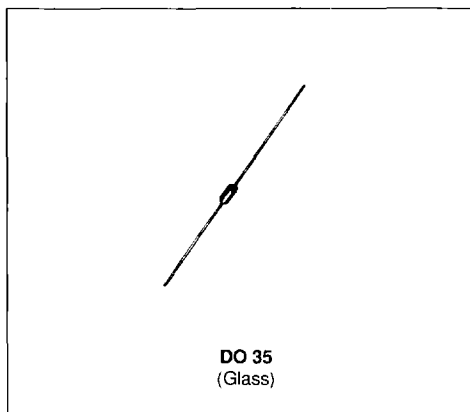

**ZENER DIODES**

- LARGE VOLTAGE RANGE : 2.4V TO 200V
- DOUBLE SLUG TYPE CONSTRUCTION

**DESCRIPTION**

500mW hermetically sealed glass silicon Zener diodes.

**ABSOLUTE RATINGS** (limiting values)

Symbol	Parameter		Value	Unit
$P_{tot}$	Power Dissipation*	$T_{amb} = 75^{\circ}\text{C}$	0.5	W
$I_{ZM}$	Continuous Reverse Current	$T_{amb} = 75^{\circ}\text{C}$	See page 2	mA
$I_{ZSM}$	Peak Reverse Current	$T_{amb} = 25^{\circ}\text{C}$	See page 2	mA
$T_{stg}$ $T_j$	Storage and Junction Temperature Range		- 65 to 200	$^{\circ}\text{C}$
$T_L$	Maximum Lead Temperature for Soldering during 10s at 4mm from Case		230	$^{\circ}\text{C}$

**THERMAL RESISTANCE**

Symbol	Parameter	Value	Unit
$R_{th(j-a)}$	Junction-ambient*	250	$^{\circ}\text{C}/\text{W}$

\* On infinite heatsink with 4mm lead length.

# 1N 5221 B → 1N 5281 B

## ELECTRICAL CHARACTERISTICS (T<sub>amb</sub> = 25°C unless otherwise specified)

Types	V <sub>ZT</sub> /I <sub>ZT</sub> *	r <sub>ZT</sub> /I <sub>ZT</sub>	I <sub>ZT</sub> *	r <sub>ZK</sub> /I <sub>ZK</sub>	α V <sub>Z</sub>	I <sub>R</sub> /V <sub>R</sub>	V <sub>R</sub>	I <sub>ZM</sub> T <sub>amb</sub> 75°C	I <sub>ZSM</sub> **
	nom (V)	max (Ω)	(mA)	max (Ω) (mA)	max (10 <sup>-4</sup> /°C)	max (μA)	(V)	(mA)	(mA)
1N 5221 B	2.4	30	20	1200 0.25	- 8.5	100	1.0	191	1984
1N 5222 B	2.5	30	20	1250 0.25	- 8.5	100	1.0	182	1905
1N 5223 B	2.7	30	20	1300 0.25	- 8.0	75	1.0	168	1764
1N 5224 B	2.8	30	20	1400 0.25	- 8.0	75	1.0	162	1701
1N 5225 B	3.0	29	20	1600 0.25	- 7.5	50	1.0	151	1587
1N 5226 B	3.3	28	20	1600 0.25	- 7.0	25	1.0	138	1443
1N 5227 B	3.6	24	20	1700 0.25	- 6.5	15	1.0	126	1323
P 1N 5228 B	3.9	23	20	1900 0.25	- 6.0	10	1.0	115	1221
P 1N 5229 B	4.3	22	20	2000 0.25	± 5.5	5	1.0	106	1107
P 1N 5230 B	4.7	19	20	1900 0.25	± 3.0	5	2.0	97	1013
P 1N 5231 B	5.1	17	20	1600 0.25	± 3.0	5	2.0	89	934
P 1N 5232 B	5.6	11	20	1600 0.25	+ 3.8	5	3.0	81	850
1N 5233 B	6.0	7.0	20	1600 0.25	+ 3.8	5	3.5	76	794
P 1N 5234 B	6.2	7.0	20	1000 0.25	+ 4.5	5	4.0	73	768
P 1N 5235 B	6.8	5.0	20	750 0.25	+ 5.0	3	5.0	67	700
P 1N 5236 B	7.5	6.0	20	500 0.25	+ 5.8	3	6.0	61	635
P 1N 5237 B	8.2	8.0	20	500 0.25	+ 6.2	2	6.5	55	581
1N 5238 B	8.7	8.0	20	600 0.25	+ 6.5	3	6.5	52	547
P 1N 5239 B	9.1	10	20	600 0.25	+ 6.8	3	7.0	50	523
P 1N 5240 B	10	17	20	600 0.25	+ 7.5	3	8.0	45	476
1N 5241 B	11	22	20	600 0.25	+ 7.6	2	8.4	41	433
P 1N 5242 B	12	30	20	600 0.25	+ 7.7	1	9.1	38	397
P 1N 5243 B	13	13	9.5	600 0.25	+ 7.9	0.5	9.9	35	397
P 1N 5244 B	14	15	9.0	600 0.25	+ 8.2	0.1	10	32	340
P 1N 5245 B	15	16	8.5	600 0.25	+ 8.2	0.1	11	30	317
P 1N 5246 B	16	17	7.8	600 0.25	+ 8.3	0.1	12	28	298
1N 5247 B	17	19	7.4	600 0.25	+ 8.4	0.1	13	27	280
P 1N 5248 B	18	21	7.0	600 0.25	+ 8.5	0.1	14	25	265
1N 5249 B	19	23	6.6	600 0.25	+ 8.6	0.1	14	24	251
1N 5250 B	20	25	6.2	600 0.25	+ 8.6	0.1	15	23	238
P 1N 5251 B	22	29	5.6	600 0.25	+ 8.7	0.1	17	21	216
P 1N 5252 B	24	33	5.2	600 0.25	+ 8.8	0.1	18	19.1	198
1N 5253 B	25	35	5.0	600 0.25	+ 8.9	0.1	19	18.2	190
1N 5254 B	27	41	4.6	600 0.25	+ 9.0	0.1	21	16.8	176
1N 5255 B	28	44	4.5	600 0.25	+ 9.1	0.1	21	16.2	170
1N 5256 B	30	49	4.2	600 0.25	+ 9.1	0.1	23	15.1	159
1N 5257 B	33	58	3.8	700 0.25	+ 9.2	0.1	25	13.8	144
1N 5258 B	36	70	3.4	700 0.25	+ 9.3	0.1	27	12.6	132
1N 5259 B	39	80	3.2	800 0.25	+ 9.4	0.1	30	11.5	122
1N 5260 B	43	93	3.0	900 0.25	+ 9.5	0.1	33	10.6	111
1N 5261 B	47	105	2.7	1000 0.25	+ 9.5	0.1	36	9.7	101
1N 5262 B	51	125	2.5	1100 0.25	+ 9.6	0.1	39	8.9	93
1N 5263 B	56	150	2.2	1300 0.25	+ 9.6	0.1	43	8.1	85
1N 5264 B	60	170	2.1	1400 0.25	+ 9.7	0.1	46	7.6	79
1N 5265 B	62	185	2.0	1400 0.25	+ 9.7	0.1	47	7.3	77
1N 5266 B	68	230	1.8	1600 0.25	+ 9.7	0.1	52	6.7	70
1N 5267 B	75	270	1.7	1700 0.25	+ 9.8	0.1	56	6.1	63
1N 5268 B	82	330	1.5	2000 0.25	+ 9.8	0.1	62	5.5	58
1N 5269 B	87	370	1.4	2200 0.25	+ 9.9	0.1	68	5.2	55
1N 5270 B	91	400	1.4	2300 0.25	+ 9.9	0.1	69	5.0	52
1N 5271 B	100	500	1.3	2600 0.25	+ 11.0	0.1	76	4.5	48
1N 5272 B	110	750	1.1	3000 0.25	+ 11.0	0.1	84	4.1	43
1N 5273 B	120	900	1.0	4000 0.25	+ 11.0	0.1	91	3.8	40

\* Measure under thermal equilibrium and DC current test conditions.

\*\* Rectangular waveform (t<sub>p</sub> = 10ms).

Tolerance on nominal V<sub>ZT</sub> value : ± 5%.

P : Preferred voltages.

Tight tolerances on preferred voltages : 1N52...C : ± 2% - 1N52... D : ± 1%.

Forward voltage drop : V<sub>F</sub> ≤ 1.1V (T<sub>amb</sub> = 25°C, I<sub>F</sub> = 200mA).

## ELECTRICAL CHARACTERISTICS (continued)

Types	$V_{ZT}/I_{ZT}^*$		$I_{ZT}^*$ (mA)	$r_{ZK}/I_{ZK}$		$\alpha \cdot V_Z$ max ( $10^{-4}/^{\circ}\text{C}$ )	$I_R/V_R$ max ( $\mu\text{A}$ )	$V_R$ (V)	$I_{ZM}$ $T_{amb}$ 75° C (mA)	$I_{ZSM}^{**}$ (mA)
	nom (V)	max ( $\Omega$ )		max ( $\Omega$ )	max (mA)					
1N 5274 B	130	1100	0.95	4500	0.25	+ 11.0	0.1	99	3.5	37
1N 5275 B	140	1300	0.90	4500	0.25	+ 11.0	0.1	106	3.2	34
1N 5276 B	150	1500	0.85	5000	0.25	+ 11.0	0.1	114	3.0	32
1N 5277 B	160	1700	0.80	5500	0.25	+ 11.0	0.1	122	2.8	30
1N 5278 B	170	1900	0.74	5500	0.25	+ 11.0	0.1	129	2.7	28
1N 5279 B	180	2200	0.68	6000	0.25	+ 11.0	0.1	137	2.5	26
1N 5280 B	190	2400	0.66	6500	0.25	+ 11.0	0.1	144	2.4	25
1N 5281 B	200	2500	0.65	7000	0.25	+ 11.0	0.1	152	2.3	24

\* Measure under thermal equilibrium and DC current test conditions.

\*\* Rectangular waveform ( $t_p = 10\text{ms}$ ).

Tolerance on nominal  $V_{ZT}$  value :  $\pm 5\%$ .

P : Preferred voltages.

Tight tolerances on preferred voltages : 1N52... C<sub>1</sub> :  $\pm 2\%$  - 1N52... D :  $\pm 1\%$ .

Forward voltage drop :  $V_F \leq 1.1\text{V}$  ( $T_{amb} = 25^{\circ}\text{C}$ ,  $I_F = 200\text{mA}$ ).

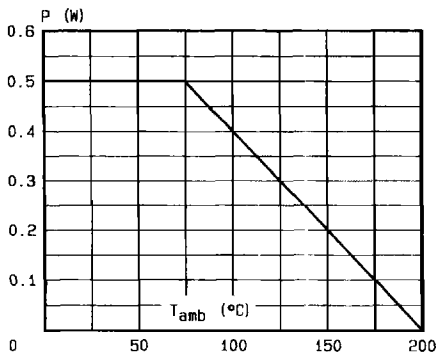

Fig.1 - Power dissipation versus ambient temperature on infinite heatsink.

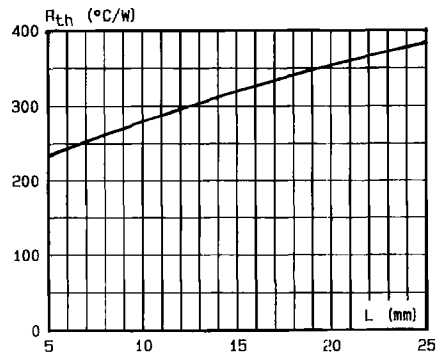

Fig.2 - Thermal resistance versus lead length on infinite heatsink.

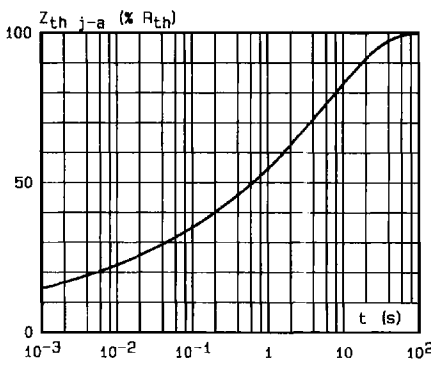

Fig.3 - Transient thermal impedance junction-ambient versus pulse duration.

INFINITE HEATSINK

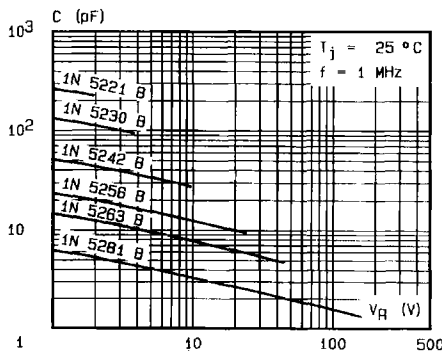
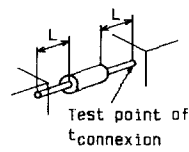

Fig.4 - Capacitance versus reverse applied voltage.

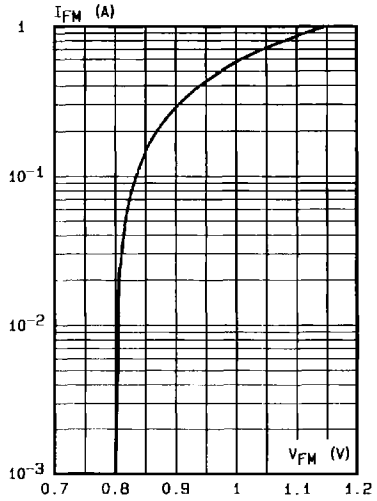

Fig.5 - Peak forward current versus peak forward voltage drop (typical values).

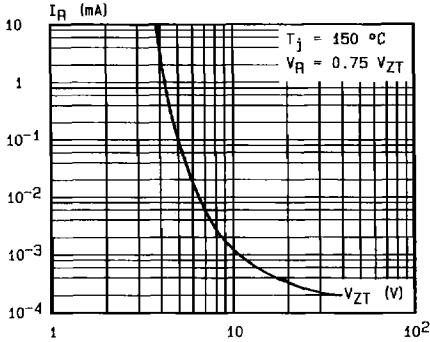

Fig.6 - Reverse current versus regulation voltage (Typical values).

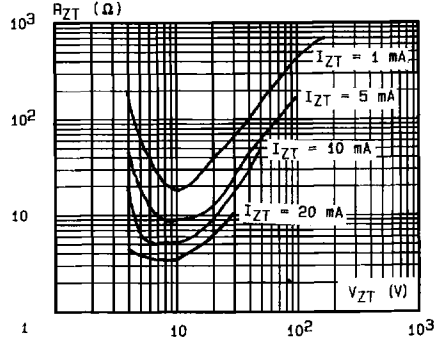

Fig.7 - Differential resistance versus regulation voltage (Typical values).

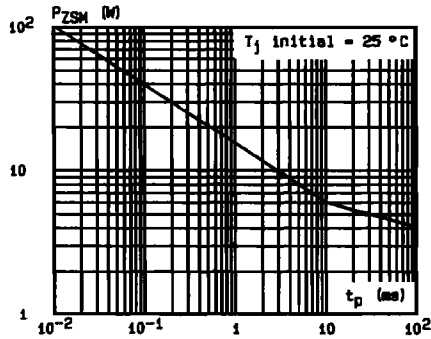
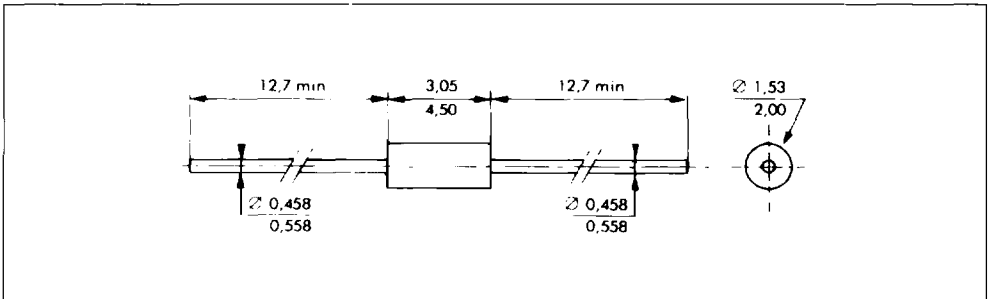

Fig.8 - Peak pulse power versus pulse duration (rectangular waveform) (maximum values).

**PACKAGE MECHANICAL DATA**

DO 35 Glass



Cooling method : by convection and conduction.  
 Marking : clear, ring at cathode end  
 Weight : 0.15g