



# CHENMKO ENTERPRISE CO.,LTD

**P6SBMJ  
SERIES**

**GLASS PASSIVATED JUNCTION TRANSIENT VOLTAGE SUPPRESSOR**  
**VOLTAGE-6.8 TO 200 VOLTS**  
**600 WATTS PEAK POWER 5.0 WATTS STEADY STATE**

*Lead free devices*

### FEATURES

- \* Plastic package
- \* 600W surge capability at 1ms
- \* Glass passivated chip junction in SMB Package
- \* Excellent clamping capability
- \* Low Zener Impedance
- \* Fast response time: typically less than 1.0ps from 0 volts to BV min.
- \* Typical IR less than 1 uA above 10V
- \* High temperature soldering guaranteed : 260°C/10 seconds at terminals

### MECHANICAL DATA

**Case:** JEDEC SMB molded plastic  
**Terminals:** Plated axial leads, solderable per MIL-STD-750, Method 2026  
**Polarity:** Color band denotes cathode end  
**Mounting Position:** Any  
**Weight:** 0.003 ounce 0.093 gram



SMB

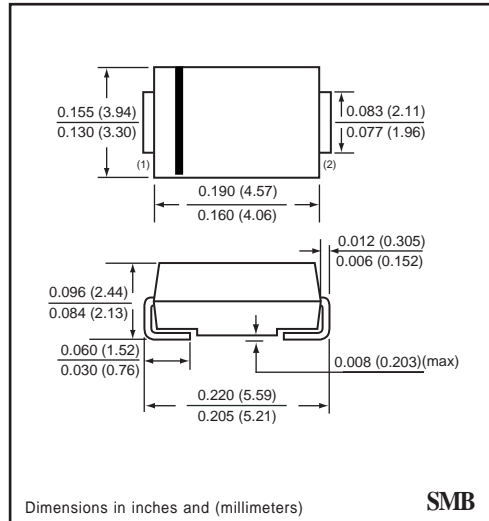

SMB

### MAXIMUM RATINGS AND ELECTRICAL CHARACTERISTICS

Ratings at 25°C ambient temperature unless otherwise specified.  
 Single phase, half wave, 60 Hz, resistive or inductive load.  
 For capacitive load, derate current by 20%.

### DEVICES FOR BIDIRECTIONAL APPLICATIONS

For Bidirectional use C or CA Suffix for types P6SBMJ6.8A thru types P6SBMJ200A  
 Electrical characteristics apply in both directions.

MAXIMUM RATINGS ( At TA = 25°C unless otherwise noted )

RATINGS	SYMBOL	VALUE	UNITS
Peak Power Dissipation at TA = 25°C, Tp = 1ms ( Note1 )	PPK	Minimum 600	Watts
Steady State Power Dissipation at TL = 75°C	PD	5.0	Watts
Peak Forward Surge Current 8.3ms Single Half Sine-Wave Superimposed on Rated Load ( Note 2 )	IFSM	100	Amps
Operating and Storage Temperature Range	TJ, TSTG	-65 to +175	°C

NOTES : 1. Non-repetitive current pulse, per Fig. 3 and derated above TA = 25°C per Fig. 2.  
 2. 8.3ms single half sine-wave, duty cycle = 4 pulses per minute maximum.  
 3. PC Board Mounted on 0.2 X 0.2" ( 5 X 5mm ) copper pad area

2003-01

PRODUCT NO.	Breakdown Voltage				Working Peak Reverse Voltage	Maximum Reverse Leakage at Vrwm	Maximum Reverse Current ( NOTE 2 )	Maximum Reverse Voltage at Irsm ( clamping )	Maximum Temperature Coefficient of Vbr
	VBR Volts ( NOTE 1 )			@ IT ( mA )					
	MIN.	NOM.	MAX.		Vrwm ( V )	Ir ( uA )	Irsm ( A )	Vrsm ( V )	( %C )
P6SBMJ6.8APT	6.45	6.8	7.14	10	5.80	1000	57	10.5	0.057
P6SBMJ7.5APT	7.13	7.5	7.88	10	6.40	500	53	11.3	0.061
P6SBMJ8.2APT	7.79	8.2	8.61	10	7.02	200	50	12.1	0.065
P6SBMJ9.1APT	8.65	9.1	9.55	1.0	7.78	50	45	13.4	0.068
P6SBMJ10APT	9.5	10	10.5	1.0	8.55	10	41	14.5	0.073
P6SBMJ11APT	10.5	11	11.6	1.0	9.40	5.0	38	15.6	0.075
P6SBMJ12APT	11.4	12	12.6	1.0	10.2	5.0	36	16.7	0.078
P6SBMJ13APT	12.4	13	13.7	1.0	11.1	5.0	33	18.2	0.081
P6SBMJ15APT	14.3	15	15.8	1.0	12.8	5.0	28	21.2	0.084
P6SBMJ16APT	15.2	16	16.8	1.0	13.6	5.0	27	22.5	0.086
P6SBMJ18APT	17.1	18	18.9	1.0	15.3	5.0	24	25.2	0.088
P6SBMJ20APT	19.0	20	21.0	1.0	17.1	5.0	22	27.7	0.090
P6SBMJ22APT	20.9	22	23.1	1.0	18.8	5.0	20	30.6	0.092
P6SBMJ24APT	22.8	24	25.2	1.0	20.5	5.0	18	33.2	0.094
P6SBMJ27APT	25.7	27	28.4	1.0	23.1	5.0	16	37.5	0.096
P6SBMJ30APT	28.5	30	31.5	1.0	25.6	5.0	14.4	41.4	0.097
P6SBMJ33APT	31.4	33	34.7	1.0	28.2	5.0	13.2	45.7	0.098
P6SBMJ36APT	34.2	36	37.8	1.0	30.8	5.0	12.0	49.9	0.099
P6SBMJ39APT	37.1	39	41.0	1.0	33.3	5.0	11.2	53.9	0.100
P6SBMJ43APT	40.9	43	45.2	1.0	36.8	5.0	10.1	59.3	0.101
P6SBMJ47APT	44.7	47	49.4	1.0	40.2	5.0	9.3	64.8	0.101
P6SBMJ51APT	48.5	51	53.6	1.0	43.6	5.0	8.6	70.1	0.102
P6SBMJ56APT	53.2	56	58.8	1.0	47.8	5.0	7.8	77.0	0.103
P6SBMJ62APT	58.9	62	65.1	1.0	53.0	5.0	7.1	85.0	0.104
P6SBMJ68APT	64.6	68	71.4	1.0	58.0	5.0	6.5	92.0	0.104
P6SBMJ75APT	71.3	75	78.8	1.0	64.1	5.0	5.8	103	0.105
P6SBMJ82APT	77.9	82	86.1	1.0	70.1	5.0	5.3	113	0.105
P6SBMJ91APT	86.5	91	95.5	1.0	77.8	5.0	4.8	125	0.106
P6SBMJ100APT	95.0	100	105	1.0	85.5	5.0	4.4	137	0.106
P6SBMJ110APT	105	110	116	1.0	94.0	5.0	4.0	152	0.107
P6SBMJ120APT	114	120	126	1.0	102	5.0	3.6	165	0.107
P6SBMJ130APT	124	130	137	1.0	111	5.0	3.3	179	0.107
P6SBMJ150APT	143	150	158	1.0	128	5.0	2.9	207	0.108
P6SBMJ160APT	152	160	168	1.0	136	5.0	2.7	219	0.108
P6SBMJ170APT	162	170	179	1.0	145	5.0	2.6	234	0.108
P6SBMJ180APT	171	180	189	1.0	154	5.0	2.4	246	0.108
P6SBMJ200APT	190	200	210	1.0	171	5.0	2.2	274	0.108

# RATING CHARACTERISTIC CURVES ( P6SBMJ6.8APT ~ P6SBMJ200APT )

FIG. 1 - PEAK PULSE POWER RATING CURVE

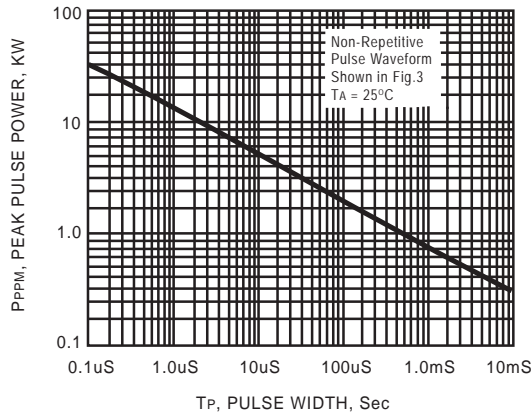

FIG. 2 - PULSE DERATING CURVE

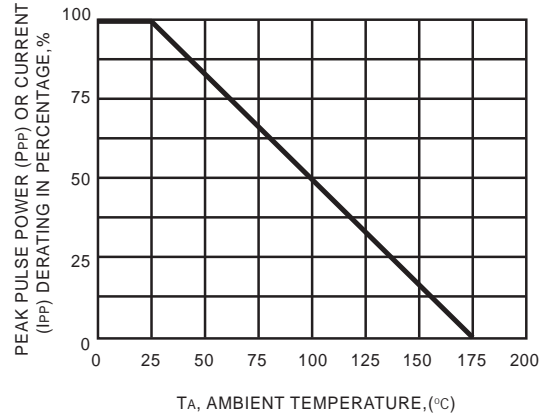

FIG. 3 - PULSE WAVEFORM

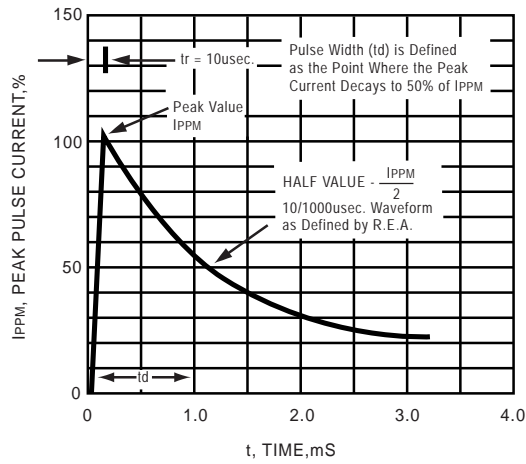
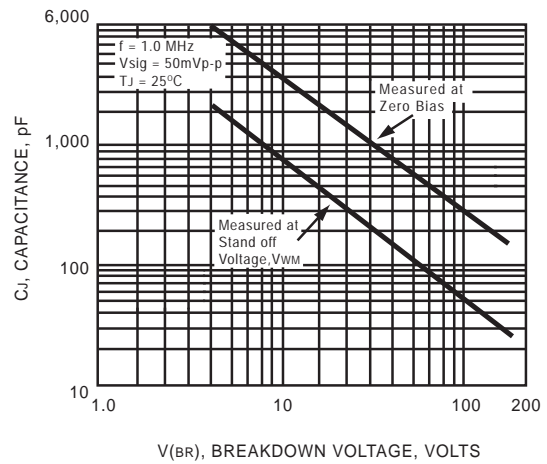

FIG. 4 - TYPICAL JUNCTION CAPACITANCE UNI-DIRECTIONAL



# RATING CHARACTERISTIC CURVES ( P6SMAJ6.8APT ~ P6SMAJ200APT )

FIG. 5 - STEADY STATE POWER DERATING CURVE

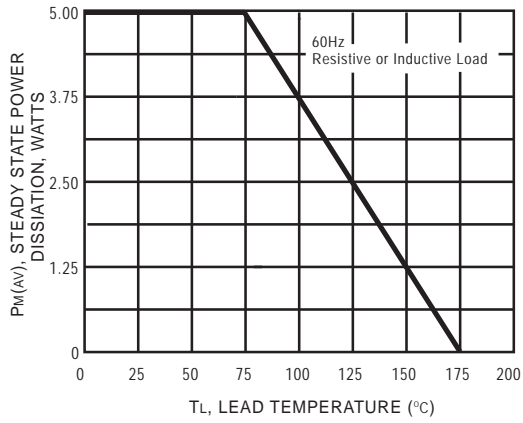

FIG. 6 - MAXIMUM NON-REPETITIVE FORWARD SURGE CURRENT UNI-DIRECTIONAL

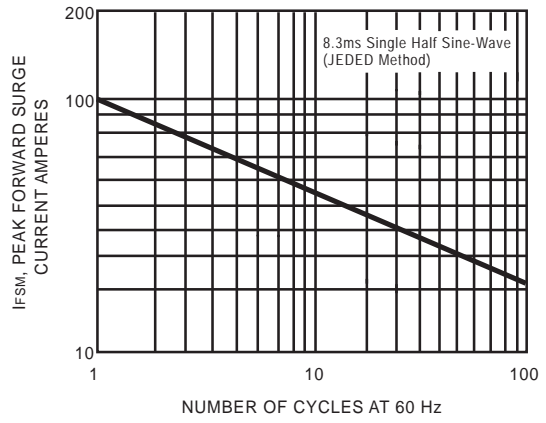

FIG. 7 - TYPICAL REVERSE LEAKAGE CHARACTERISTICS

