



# TTL Compatible CMOS Analog Switches

DG300(A)/DG301(A)/DG302(A)/DG303(A)

## General Description

Maxim's DG300-DG303 and DG300A-DG303A CMOS dual and quad analog switches combine low power operation with fast switching times and superior DC and AC switch characteristics. On-resistance is less than 50Ω and is essentially constant over the analog signal range. Device specifications are ideal for battery-powered circuitry.

These switches are available in a variety of formats as outlined in the *Pin Configurations* section. The switch control logic inputs are fully TTL and CMOS compatible. Also featured are "break-before-make" switching and low charge injection.

Maxim's DG300-DG303 and DG300A-DG303A families are electrically compatible and pin compatible with the original manufacturer's devices. All devices operate with power supplies ranging from ±5V to ±18V. Single-supply operation is implemented by connecting V- to GND.

## Applications

- Portable Instruments
- Low-Power Sample/Holds
- Power-Supply Switching
- Programmable Gain Amplifiers
- SPDT and DPDT Functions
- Process Control and Telemetry

## Features

- ◆ Monolithic Low-Power CMOS
- ◆ Latchup Proof Construction
- ◆ Fully Compatible 2nd Source
- ◆ Low On-Resistance, <50Ω
- ◆ Fast Switching Time
- ◆ V+ to V- Analog Signal Range
- ◆ Single-Supply Capability

## Ordering Information

PART	TEMP RANGE	PIN-PACKAGE
DG300C/D	0°C to +70°C	Dice
DG300CJ	0°C to +70°C	14 Lead Plastic DIP
DG300CWE	0°C to +70°C	16 Lead Wide SO
DG300CK	0°C to +70°C	14 Lead CERDIP
DG300BWE	-25°C to +85°C	16 Lead Wide SO
DG300BK	-25°C to +85°C	14 Lead CERDIP
DG300BA	-25°C to +85°C	10 Lead Metal Can
DG300AK	-55°C to +125°C	14 Lead CERDIP
DG300AA	-55°C to +125°C	10 Lead Metal Can

Ordering Information continued at end of data sheet.

## Pin Configurations

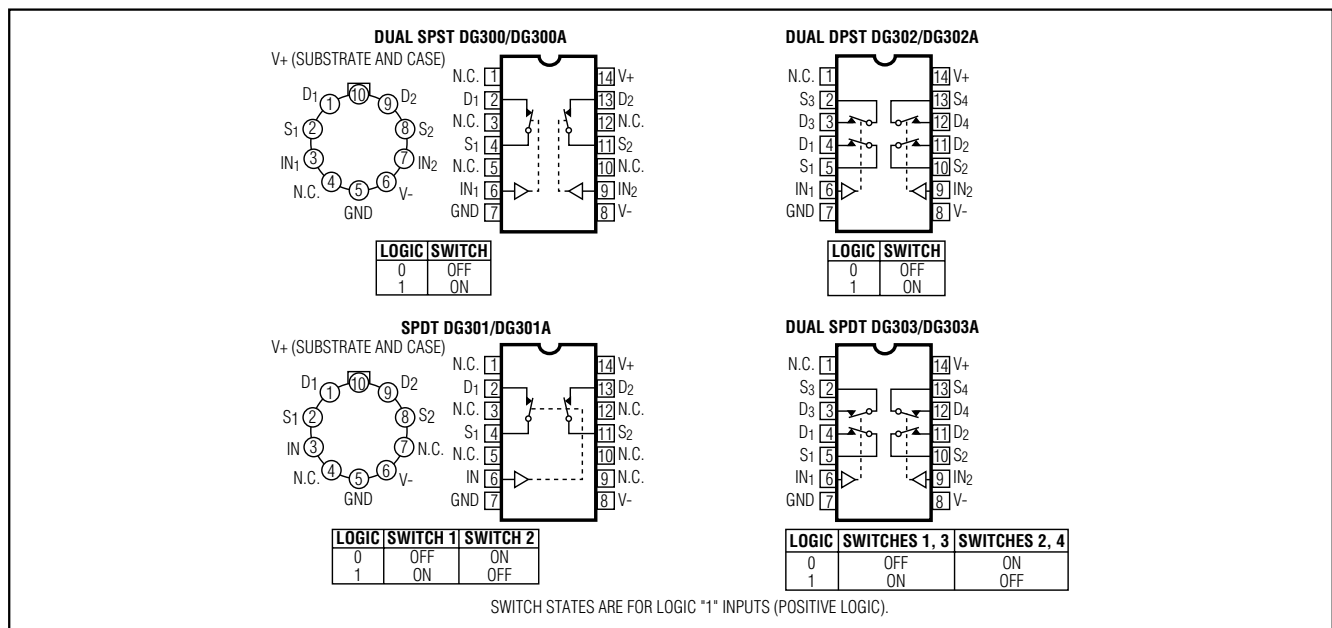

For pricing, delivery, and ordering information, please contact Maxim/Dallas Direct! at 1-888-629-4642, or visit Maxim's website at [www.maxim-ic.com](http://www.maxim-ic.com).

# TTL Compatible CMOS Analog Switches

## ABSOLUTE MAXIMUM RATINGS

Voltages Referenced to V-

V+ (DG300–DG303).....	36V
V+ (DG300A–DG303A).....	44V
GND .....	25V
Digital Inputs, V <sub>S</sub> , V <sub>D</sub> , (Note 1).....	-4V to (V+ + 4V) or 30mA, whichever occurs first
Current, Any Terminal Except S or D.....	30mA
Continuous Current, S or D .....	30mA
(pulsed at 1ms, 10% duty cycle max) .....	100mA
Storage Temperature (A & B suffix).....	-65°C to +150°C
(C suffix).....	-65°C to +125°C

Operating Temperature (A suffix).....	-55°C to +125°C
(B suffix).....	-25°C to +85°C
(C suffix).....	0°C to +70°C
Lead Temperature (soldering 10s).....	+300°C
Power Dissipation*	
Cerdip (K) (derate 11mW/°C above +75°C).....	825mW
Plastic DIP (J) (derate 6.5mW/°C above +25°C) .....	470mW
Metal Can (A) (derate 6mW/°C above +75°C).....	450mW

\*Device mounted with all leads soldered or welded to PC board.

Stresses beyond those listed under "Absolute Maximum Ratings" may cause permanent damage to the device. These are stress ratings only, and functional operation of the device at these or any other conditions beyond those indicated in the operational sections of the specifications is not implied. Exposure to absolute maximum rating conditions for extended periods may affect device reliability.

## ELECTRICAL CHARACTERISTICS

(V+ = +15V, V- = -15V, GND = 0V, T<sub>A</sub> = +25°C, unless otherwise noted.)

	PARAMETER	SYMBOL	TEST CONDITIONS	DG300–DG303A DG300A–DG303AA			DG300–DG303B/C DG300A–DG303AB/C			UNITS	
				MIN	TYP	MAX	MIN	TYP	MAX		
				(Note 2) (Note 3)			(Note 2) (Note 3)				
SWITCH	Analog Signal Range	V <sub>ANALOG</sub>	I <sub>S</sub> = 10mA, V <sub>IN</sub> = 0.8V or 4.0V	-15		+15	-15		+15	V	
	Drain-Source ON-Resistance	R <sub>DS(ON)</sub>	I <sub>S</sub> = -10mA, V <sub>D</sub> = 10V I <sub>S</sub> = -10mA, V <sub>D</sub> = -10V	30		50	30		50	Ω	
				0.1		1	0.1		5	nA	
	Source OFF- Leakage Current	I <sub>S(OFF)</sub>	V <sub>IN</sub> = 0.8V or V <sub>IN</sub> = 0.8V	V <sub>S</sub> = 14V, V <sub>D</sub> = -14V V <sub>S</sub> = -14V, V <sub>D</sub> = 14V	-1	-0.1	1	-5	-0.1	5	nA
	Drain OFF- Leakage Current	I <sub>D(OFF)</sub>		V <sub>S</sub> = 14V, V <sub>D</sub> = -14V V <sub>D</sub> = V <sub>S</sub> = 14V	-1	-0.1	1	-5	-0.1	5	nA
	Drain ON- Leakage Current	I <sub>D(ON)</sub>	V <sub>D</sub> = V <sub>S</sub> = 14V V <sub>D</sub> = V <sub>S</sub> = -14V	-2	-0.1	2	-5	-0.1	5	nA	
INPUT	Input Current/ Voltage High	I <sub>INH</sub>	V <sub>IN</sub> = 5.0V V <sub>IN</sub> = 15V	-1	-0.001	1	-1	-0.001	1	μA	
	Input Current/ Voltage Low	I <sub>INL</sub>	V <sub>IN</sub> = 0V	-1	-0.001	1	-1	-0.001	1	μA	
DYNAMIC	Turn-ON Time	t <sub>ON</sub>	See Switching Time Test Circuit	150		300	150		300	ns	
	Turn-OFF Time	t <sub>OFF</sub>		130		250	130		250	ns	
	Break-Before-Make Interval	t <sub>ON</sub> - t <sub>OFF</sub>	See Break-Before-Make Time Test Circuit, DG301(A)/DG303(A) only	50			50			ns	
	Charge Injection	Q	C <sub>L</sub> = 10nF, R <sub>GEN</sub> = 0Ω, V <sub>GEN</sub> = 0V	12			12			pC	
	Source OFF- Capacitance	C <sub>S(OFF)</sub>	f = 1MHz, V <sub>S</sub> = 0V	14			14			pF	
	Drain OFF- Capacitance	C <sub>D(OFF)</sub>	V <sub>IN</sub> = 0.8V or V <sub>IN</sub> = 4.0V	14			14			pF	
	Channel ON- Capacitance	C <sub>D(ON)</sub> + C <sub>S(ON)</sub>	V <sub>S</sub> = V <sub>D</sub> = 0V	40			40			pF	
	Input Capacitance	C <sub>IN</sub>	f = 1MHz	6			6			pF	
			V <sub>IN</sub> = 15V	7			7				
Off-Isolation (Note 4)		V <sub>IN</sub> = 0V, R <sub>L</sub> = 1kΩ	62			62			dB		
Crosstalk (Channel-to-Channel)		V <sub>S</sub> = 1V <sub>RMS</sub> , f = 500kHz	74			74			dB		

# TTL Compatible CMOS Analog Switches

DG300(A)/DG301(A)/DG302(A)/DG303(A)

## ELECTRICAL CHARACTERISTICS (continued)

(V+ = +15V, V- = -15V, GND = 0V, TA = +25°C, unless otherwise noted.)

	PARAMETER	SYMBOL	TEST CONDITIONS	DG300–DG303A DG300A–DG303AA			DG300–DG303B/C DG300A–DG303AB/C			UNITS
				MIN	TYP	MAX	MIN	TYP	MAX	
				(Note 2)	(Note 3)		(Note 2)	(Note 3)		
SUPPLY	Positive Supply Current	I+	VIN = 4V (one input) (all others = 0)	0.23	0.5		0.23	0.5	mA	
	Negative Supply Current	I-		-10	-0.001		-10	-0.001	μA	
	Positive Supply Current	I+	VIN = 0.8V (all inputs)	0.001	10		0.001	10	μA	
	Negative Supply Current	I-		-10	-0.001		-10	-0.001	μA	

## ELECTRICAL CHARACTERISTICS (Over Temperature)

(V+ = +15V, V- = -15V, GND = 0V, TA = Over Temperature Range, unless otherwise noted.)

	PARAMETER	SYMBOL	TEST CONDITIONS	DG300–DG303A DG300A–DG303AA			DG300–DG303B/C DG300A–DG303AB/C			UNITS
				MIN	TYP	MAX	MIN	TYP	MAX	
				(Note 2)	(Note 3)		(Note 2)	(Note 3)		
SWITCH	Analog Signal Range	VANALOG	IS = -10mA, VIN = 0.8V or 4.0V	-15		+15	-15		+15	V
	Drain-Source ON-Resistance	RDS(ON)	VIN = 0.8V or VIN = 0.8V	IS = -10mA, VD = 10V		75			75	Ω
	Source OFF-Leakage Current	IS(OFF)		IS = -10mA, VD = -10V		75			75	nA
				VS = 14V, VD = -14V		100			100	
	Drain OFF-Leakage Current	ID(OFF)		VS = -14V, VD = 14V		-100			-100	nA
				VS = 14V, VD = -14V		-100			-100	
Drain ON-Leakage Current	ID(ON)	VD = VS = 14V			200			200		nA
		VD = VS = -14V		-200			-200			nA
INPUT	Input Current/ Voltage High	IINH	VIN = 5.0V	-1			-10			μA
			VIN = 15V		1			10		μA
	Input Current/ Voltage Low	IINL	VIN = 0V	-1			-10			μA
SUPPLY	Positive Supply Current	I+	VIN = 4V (one input) (all others = 0)			1			1	mA
	Negative Supply Current	I-		-100			-200			mA
	Positive Supply Current	I+	VIN = 0.8V (all inputs)			100			200	μA
	Negative Supply Current	I-		-100			-200			μA
DYNAMIC	Turn-ON Time	tON	See Switching Time Test Circuit			500				ns
	Turn-OFF Time	tOFF				450				ns

# TTL Compatible CMOS Analog Switches

## ELECTRICAL CHARACTERISTICS (Over Temperature) (continued)

(V+ = +15V, V- = -15V, GND = 0V, TA = Over Temperature Range, unless otherwise noted.)

- Note 1:** Signals on SX, DX, or INX exceeding V+ or V- are clamped by internal diodes. Limit diode forward current to maximum current ratings.
- Note 2:** The algebraic convention whereby the most negative value is a minimum, and the most positive value is a maximum is used in this data sheet.
- Note 3:** Typical values are for DESIGN AID ONLY, not guaranteed nor subject to production testing.
- Note 4:** OFF-isolation =  $20 \log \frac{V_S}{V_D}$ , VS = input to OFF switch, VD = output.

## Typical Operating Characteristics

(TA = +25°C, unless otherwise noted.)

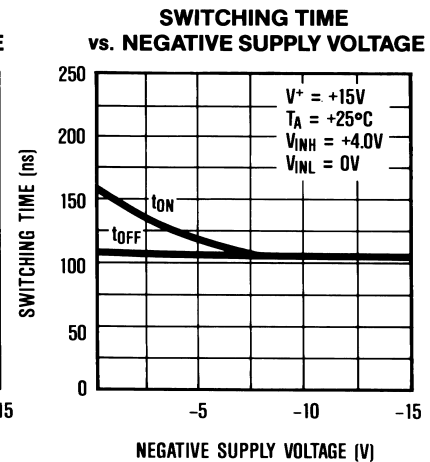
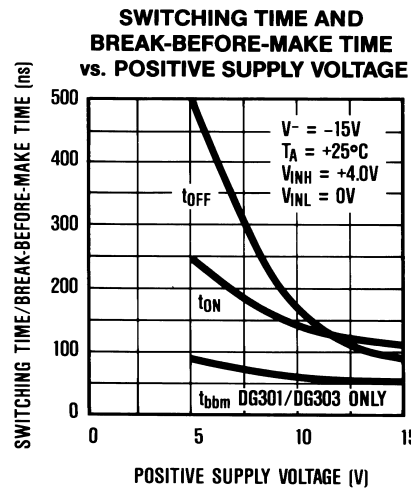
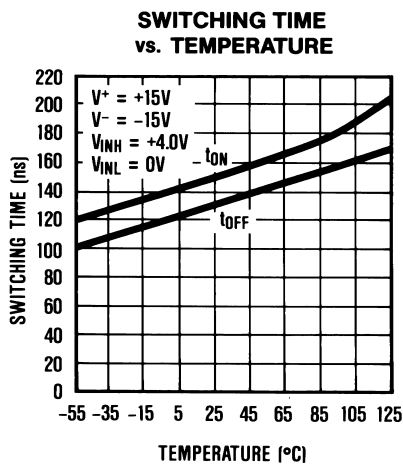
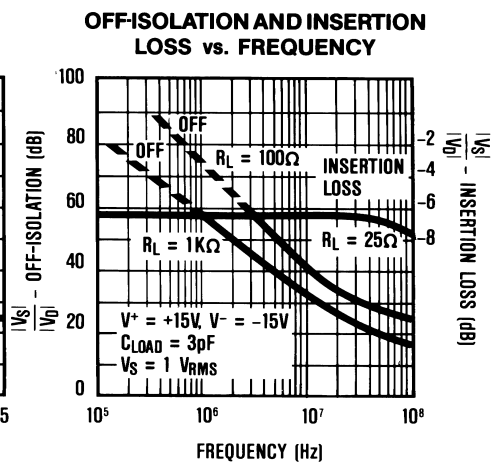
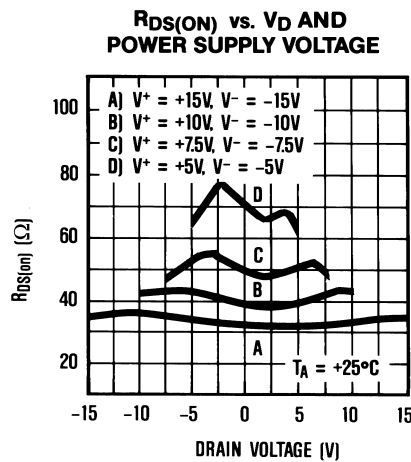
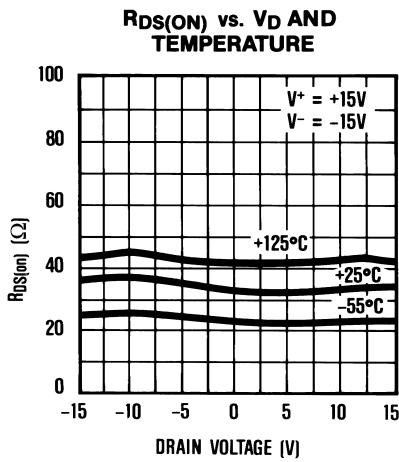

# TTL Compatible CMOS Analog Switches

## Test Circuits

DG300(A)/DG301(A)/DG302(A)/DG303(A)

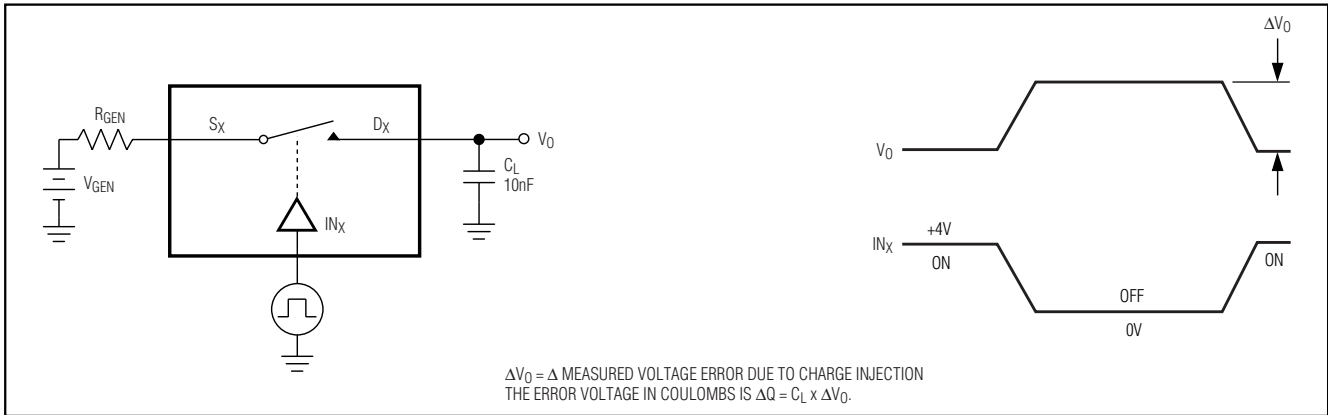

Figure 1. Charge Injection Test Circuit

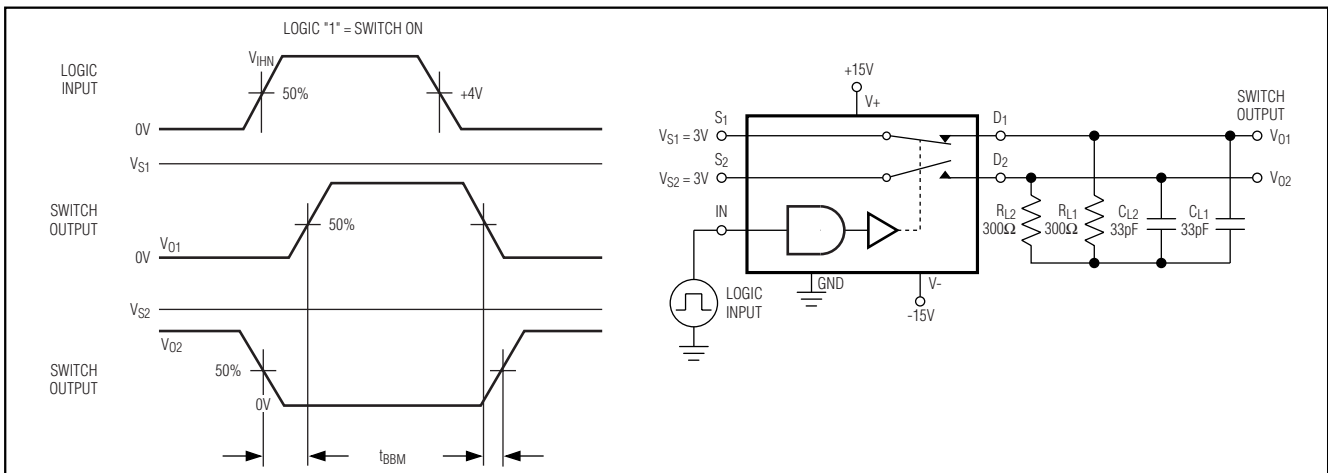

Figure 2. Break-Before-Make Time Test Circuit SPDT (DG301(A), DG303(A))

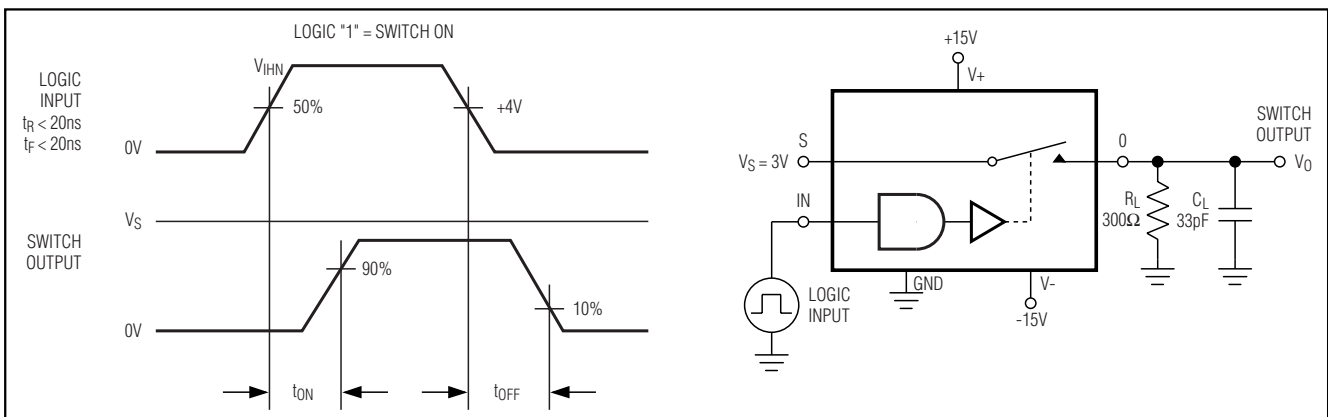

Figure 3. Switching Time Test Circuit

# TTL Compatible CMOS Analog Switches

**Table 1. Typical Single Supply Parameters**

PARAMETER		V+ SUPPLY VOLTAGE (V- = 0V)			
		+10V	+15V	+20V	+30V
Switching Time (RL = 1kΩ)	tON	190ns	150ns	110ns	70ns
	tOFF	40ns	40ns	40ns	40ns
On-Resistance	V <sub>SIGNAL</sub> = +1V	71Ω	51Ω	42Ω	31Ω
	V <sub>SIGNAL</sub> = V+ / 2	77Ω	54Ω	43Ω	30Ω
	V <sub>SIGNAL</sub> = V+	84Ω	63Ω	54Ω	43Ω
Input Logic Levels		0.8V, 4.0V	0.8V, 4.0V	0.8V, 4.0V	0.8V, 4.5V

## Applications Information

All DG300 family switches will operate with ±5V to ±15V power supplies. They can also be used with single-ended power supplies ranging from +10V to +30V where the V-terminal is connected to ground. In either case, analog signals ranging from V+ to V- can be switched.

The on-resistance variation with analog signal and supply voltage is shown in the *Typical Operating Characteristics*. The temperature coefficient of RON is typically 0.5%/°C. Typical on-resistance matching from channel to channel is 10%. In addition, Table 1 outlines some typical parameters for single-supply operation.

**Table 2. Charge Injection (±15V Supplies)**

ANALOG INPUT (V)	INJECTED Q (pC)
+10	4
+5	8
0	12
-5	8
-10	5

The charge injection test circuit is shown in Figure 1. Table 2 lists the typical injected charge for DG300 series switches with various input voltages.

## Chip Topography

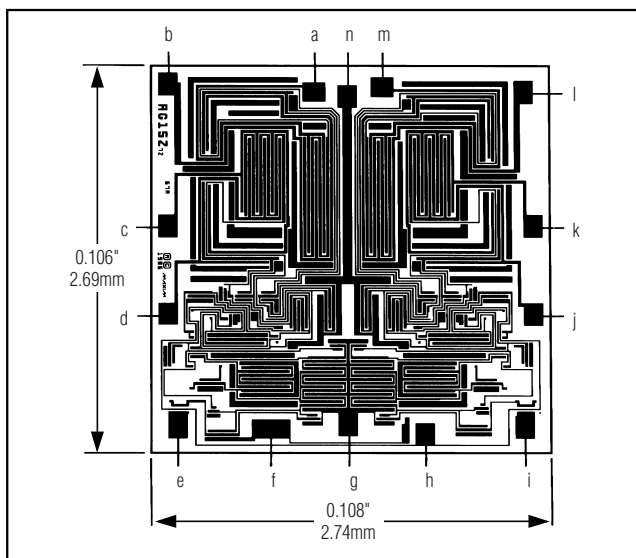

DIE PAD	DG300 DG300A	DG301 DG301A	DG302/DG303 DG302A/DG303A
a	N.C.	N.C.	S3
b	D1	D1	D3
c	D1	S1	D1
d	S1	IN1	S1
e	IN1	IN1	IN1
f	V+	V+	V+
g	GND	GND	GND
h	V-	V-	V-
i	IN2	GND	IN2
j	S2	V-	S2
k	D2	S2	D2
l	D2	D2	D4
m	N.C.	N.C.	S4
n	V+	V+	V+

# TTL Compatible CMOS Analog Switches

## Ordering Information (continued)

PART	TEMP RANGE	PIN-PACKAGE
DG300AC/D	0°C to +70°C	Dice
DG300ACJ	0°C to +70°C	14 Lead Plastic DIP
DG300ACWE	0°C to +70°C	16 Lead Wide SO
DG300ACK	0°C to +70°C	14 Lead CERDIP
DG300ABWE	-25°C to +85°C	16 Lead Wide SO
DG300ABK	-25°C to +85°C	14 Lead CERDIP
DG300ABA	-25°C to +85°C	10 Lead Metal Can
<b>DG301C/D</b>	0°C to +70°C	Dice
DG301CJ	0°C to +70°C	14 Lead Plastic DIP
DG301CWE	0°C to +70°C	16 Lead Wide SO
DG301CK	0°C to +70°C	14 Lead CERDIP
DG301BWE	-25°C to +85°C	16 Lead Wide SO
DG301BK	-25°C to +85°C	14 Lead CERDIP
DG301BA	-25°C to +85°C	10 Lead Metal Can
DG301AK	-55°C to +125°C	14 Lead CERDIP
DG301AA	-55°C to +125°C	10 Lead Metal Can
DG301AC/D	0°C to +70°C	Dice
DG301ACJ	0°C to +70°C	14 Lead Plastic DIP
DG301ACWE	0°C to +70°C	16 Lead Wide SO
DG301ACK	0°C to +70°C	14 Lead CERDIP
DG301ABWE	-25°C to +85°C	16 Lead Wide SO
DG301ABK	-25°C to +85°C	14 Lead CERDIP
DG301ABA	-25°C to +85°C	10 Lead Metal Can
<b>DG302C/D</b>	0°C to +70°C	Dice
DG302CJ	0°C to +70°C	14 Lead Plastic DIP

PART	TEMP RANGE	PIN-PACKAGE
DG302CWE	0°C to +70°C	16 Lead Wide SO
DG302CK	0°C to +70°C	14 Lead CERDIP
DG302BWE	-25°C to +85°C	16 Lead Wide SO
DG302BK	-25°C to +85°C	14 Lead CERDIP
DG302AK	-55°C to +125°C	14 Lead CERDIP
DG302AC/D	0°C to +70°C	Dice
DG302ACJ	0°C to +70°C	14 Lead Plastic DIP
DG302ACWE	0°C to +70°C	16 Lead Wide SO
DG302ACK	0°C to +70°C	14 Lead CERDIP
DG302ABWE	-25°C to +85°C	16 Lead Wide SO
DG302ABK	-25°C to +85°C	14 Lead CERDIP
<b>DG303C/D</b>	0°C to +70°C	Dice
DG303CJ	0°C to +70°C	14 Lead Plastic DIP
DG303CWE	0°C to +70°C	16 Lead Wide SO
DG303CK	0°C to +70°C	14 Lead CERDIP
DG303BWE	-25°C to +85°C	16 Lead Wide SO
DG303BK	-25°C to +85°C	14 Lead CERDIP
DG303AK	-55°C to +125°C	14 Lead CERDIP
DG303AC/D	0°C to +70°C	Dice
DG303ACJ	0°C to +70°C	14 Lead Plastic DIP
DG303ACWE	0°C to +70°C	16 Lead Wide SO
DG303ACK	0°C to +70°C	14 Lead CERDIP
DG303ABWE	-25°C to +85°C	16 Lead Wide SO
DG303ABK	-25°C to +85°C	14 Lead CERDIP

**DG300(A)/DG301(A)/DG302(A)/DG303(A)**

# TTL Compatible CMOS Analog Switches

## Package Information

(The package drawing(s) in this data sheet may not reflect the most current specifications. For the latest package outline information, go to [www.maxim-ic.com/packages](http://www.maxim-ic.com/packages).)

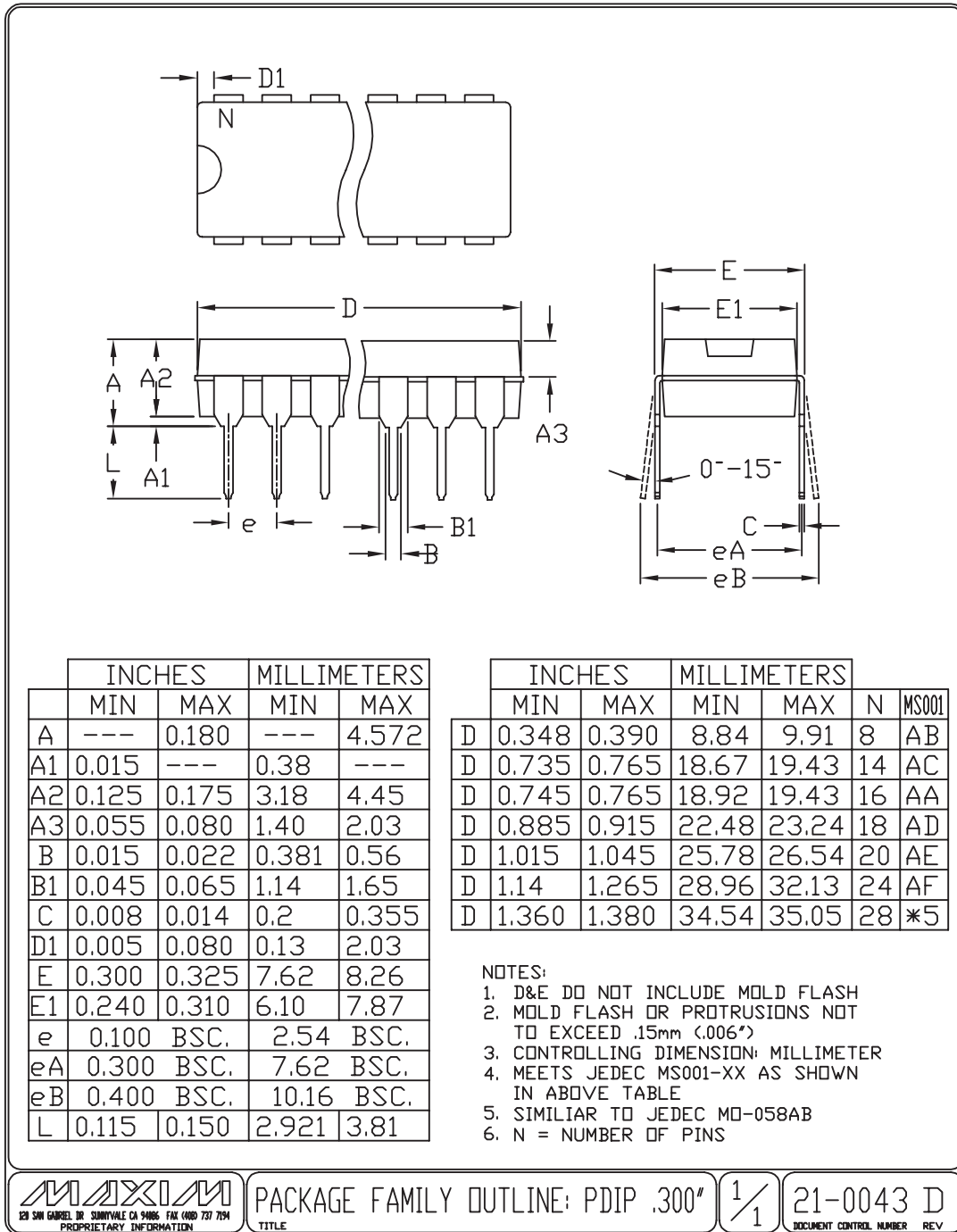

PACKAGE FAMILY OUTLINE: PDIP .300" TITLE

1/1

21-0043 D DOCUMENT CONTROL NUMBER REV



# TTL Compatible CMOS Analog Switches

## Package Information (continued)

(The package drawing(s) in this data sheet may not reflect the most current specifications. For the latest package outline information, go to [www.maxim-ic.com/packages](http://www.maxim-ic.com/packages).)

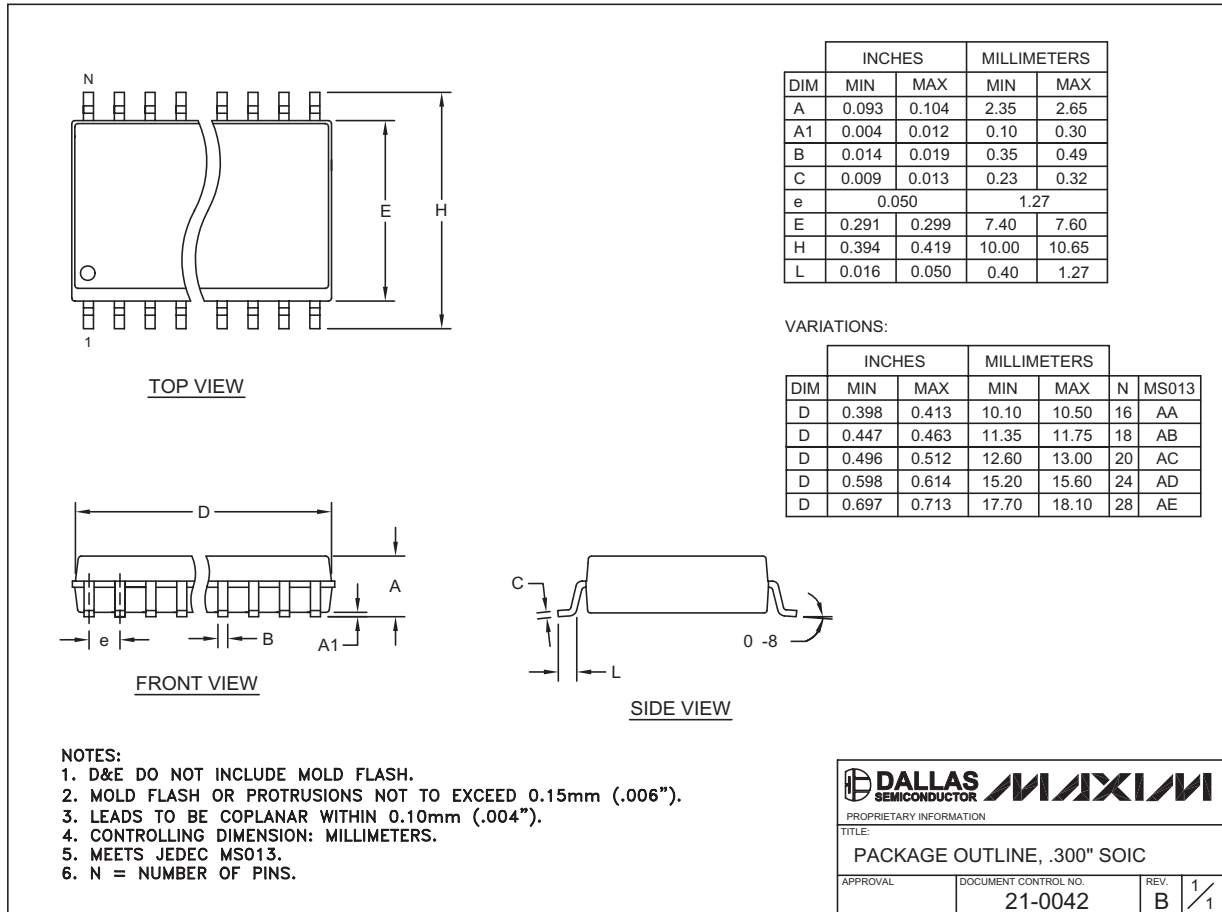

DG300(A)/DG301(A)/DG302(A)/DG303(A)

# TTL Compatible CMOS Analog Switches

## Package Information (continued)

(The package drawing(s) in this data sheet may not reflect the most current specifications. For the latest package outline information, go to [www.maxim-ic.com/packages](http://www.maxim-ic.com/packages).)

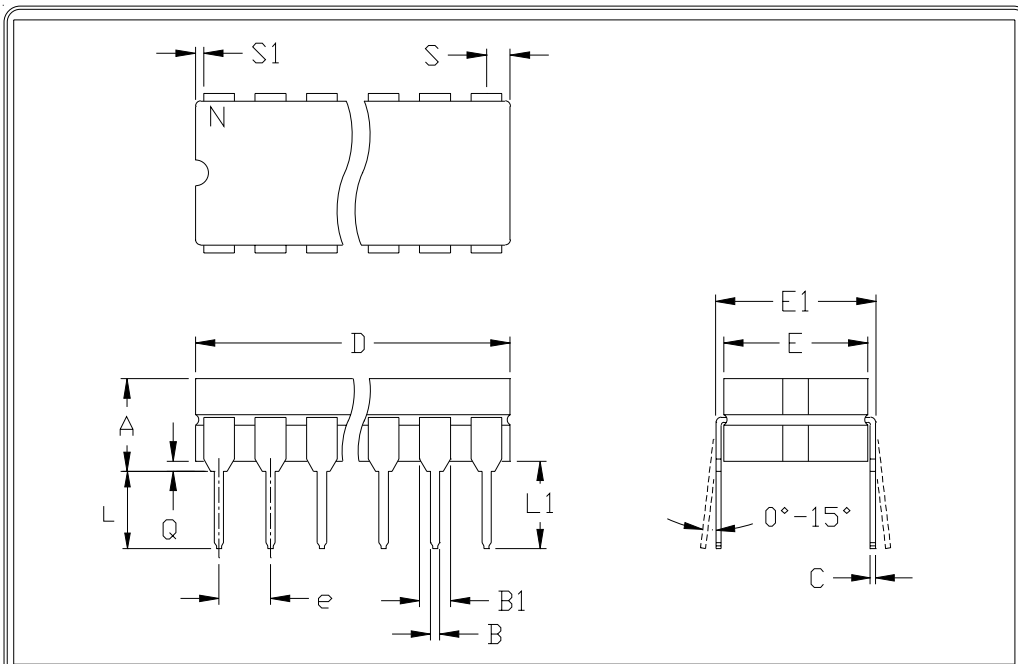

	INCHES		MILLIMETERS	
	MIN	MAX	MIN	MAX
A	---	0.200	---	5.08
B	0.014	0.023	0.36	0.58
B1	0.038	0.065	0.97	1.65
C	0.008	0.015	0.20	0.38
E	0.220	0.310	5.59	7.87
E1	0.290	0.320	7.37	8.13
e	0.100		2.54	
L	0.125	0.200	3.18	5.08
L1	0.150	---	0.00	---
Q	0.015	0.070	0.38	1.78
S	---	0.098	---	2.49
S1	0.005	---	0.13	---

	INCHES		MILLIMETERS		N	CASE
	MIN	MAX	MIN	MAX		
D	---	0.405	---	10.29	8	P:D4
D	---	0.785	---	19.94	14	C:D1
D	---	0.840	---	21.34	16	E:D2
D	---	0.960	---	24.38	18	V:D6
D	---	1.060	---	26.92	20	R:D8
D	---	1.280	---	32.51	24	L:D9

- NOTES:  
 1. CONTROLLING DIMENSION: INCH  
 2. MEETS 1835 CASE OUTLINE CONFIGURATION #1 AS SHOWN IN ABOVE TABLE  
 3. N = NUMBER OF PINS

 <small>120 SAN GABRIEL DR. SUNNYVALE CA 94086 FAX (408) 737-7394                  PROPRIETARY INFORMATION</small>	PACKAGE FAMILY OUTLINE: CDIP .300" <small>TITLE</small>	$\frac{1}{1}$	21-0045 A <small>DOCUMENT CONTROL NUMBER REV</small>
---	--	---------------	---

Maxim cannot assume responsibility for use of any circuitry other than circuitry entirely embodied in a Maxim product. No circuit patent licenses are implied. Maxim reserves the right to change the circuitry and specifications without notice at any time.

10 \_\_\_\_\_ **Maxim Integrated Products, 120 San Gabriel Drive, Sunnyvale, CA 94086 408-737-7600**